

CFL



IKO US LOCATIONS

East Coast

91 Walsh Drive
Parsippany, NJ 07054
Toll Free: 800-922-0337
Phone: 973-402-0254
Fax: 973-402-0441
E-mail: eco@ikonet.co.jp

Midwest

101 Mark Street
Unit-G
Wood Dale, IL 60191
Toll Free: 800-323-6694
Phone: 630-766-6464
Fax: 630-766-6869
E-mail: mwo@ikonet.co.jp

West Coast

9830 Norwalk Blvd.
Suite 198
Santa Fe Springs, CA 90670
Toll Free: 800-252-3665
Phone: 562-941-1019
Fax: 562-941-4027
E-mail: wco@ikonet.co.jp

Southeast

3235 Satellite Boulevard
Building 400, Suite 230
Duluth, GA 30096
Toll Free: 800-874-6445
Phone: 770-418-1904
Fax: 770-418-9403
E-mail: seo@ikonet.co.jp

Southwest

6191 N. State Highway 161
Suite 440
Irving, TX 75038
Toll Free: 800-295-7886
Phone: 972-925-0444
Fax: 972-707-0385
E-mail: swo@ikonet.co.jp

Silicon Valley

1500 Wyatt Dr.
Suite 10
Santa Clara, CA 95054
Phone: 408-492-0240
Fax: 408-492-0245
E-mail: wco@ikonet.co.jp

New



CFL

Cam Followers with Resin Outer Ring

www.ikont.com

Outer ring integrally molded with resin and steel plate!

Compact Cam Followers with Resin Outer Ring

The extremely compact Cam Followers with Resin Outer Ring CFL have an embedded outer ring integrally molded from resin. **Self-lubricating Type (POM)** and **Shock-absorbing Type (TPU)** are available depending on your application.

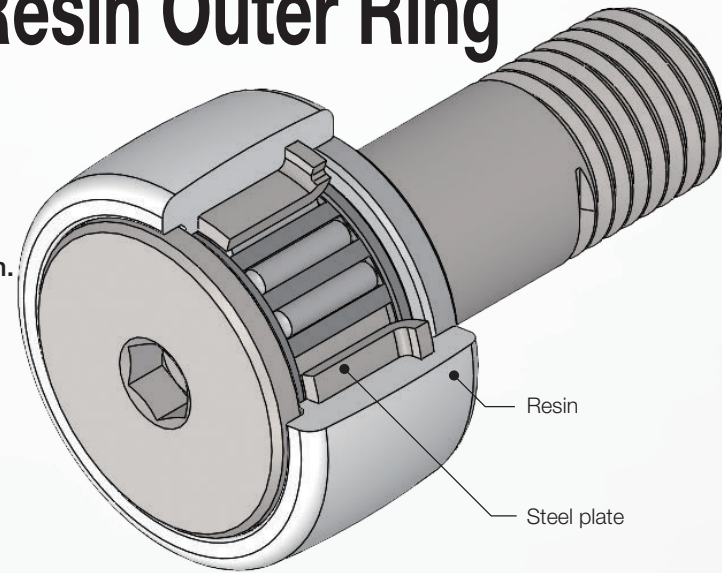

Dimensions

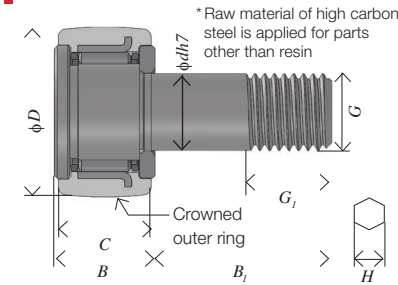

Self-lubricating Type (POM)

Stud diameter mm	Identification number	Boundary dimensions mm								Max. tightening torque N·m	Allowable load N	Allowable rotational speed min ⁻¹
		D	C	d	G	G _i	B max	B _i	H			
6	CFL 6PB	16	11	6	M 6 × 1	8	12.2	16	3	2.7	150	2620
8	CFL 8PB	19	11	8	M 8 × 1.25	10	12.2	20	4	6.5	237	2210
10	CFL10PB	22	12	10	M10 × 1.25	12	13.2	23	4	13.8	284	1900
12	CFL12PB	30	14	12	M12 × 1.5	13	15.2	25	6	21.9	365	1400

Operating ambient temperature (reference): -20 to 50°C

Shock-absorbing Type (TPU)

Stud diameter mm	Identification number	Boundary dimensions mm								Max. tightening torque N·m	Allowable load N	Allowable rotational speed min ⁻¹
		D	C	d	G	G _i	B max	B _i	H			
6	CFL 6TB	16	11	6	M 6 × 1	8	12.2	16	3	2.7	20	1830
8	CFL 8TB	19	11	8	M 8 × 1.25	10	12.2	20	4	6.5	23	1550
10	CFL10TB	22	12	10	M10 × 1.25	12	13.2	23	4	13.8	40	1330
12	CFL12TB	30	14	12	M12 × 1.5	13	15.2	25	6	21.9	46	980

Operating ambient temperature (reference): -20 to 50°C

Grease filled (brand and code)	Shell Alvania S2
Oil hole	without
Seal	without
Nut	Included
Recommended stud fit	H7

Problem

Large outside diameter of outer ring

For **Conventional Resin Cam Followers**, resin is wrapped onto the outer ring of **Standard Type Cam Followers**, leading to a larger outer diameter of the outer ring.



Solution

Up to 33% smaller outer diameter of outer ring comparing with Conventional Resin Cam Followers.

The use of an outer ring integrally molded from resin and steel plate achieves the same dimensions as **Standard Type Cam Followers**. Replacement of **Standard Type Cam Followers** is possible without design changes.

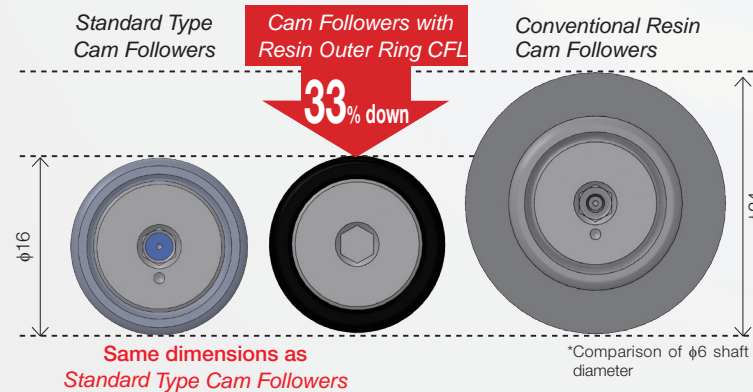

Comparison table of outer diameter of outer ring

Stud diameter mm	Outside diameter of outer ring mm			Ratio compared to Conventional Resin Cam Followers
	Standard Type Cam Followers	Cam Followers with Resin Outer Ring CFL	Conventional Resin Cam Followers	
6	16	16	24	-33%
8	19	19	27	-30%
10	22	22	30	-27%
12	30	30	38	-21%

*Product available for sale

Product Types

Self-lubricating Type (POM)

- Lesser deformation than the shock-absorbing type, with higher allowable load
- Resin with high lubrication is used, enabling smooth guidance



Shock-absorbing Type (TPU)

- Elastic urethane rubber (Shore Hardness: A90) is used to absorb shock load and vibration
- Lactone-based polyurethane, with excellent mechanical properties and hydrolysis resistance, is used



* For both types, no need to grease surface of the outer ring; avoids contamination to the surrounding environment.

Features

Quiet

The resin absorbs vibration and suppresses noise during rotation. A quiet environment can be maintained without using covers or sheets.

Scratch-proof

Preventing damages and scratches of workpieces. It's also very suitable to be used in the conveying part of precision machines.

Maintenance-free

Long-term use is possible without greasing onto the outside diameter surface. It prevents contamination of the surrounding environment.

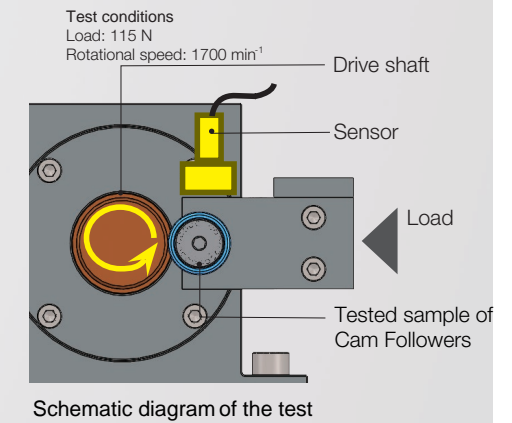
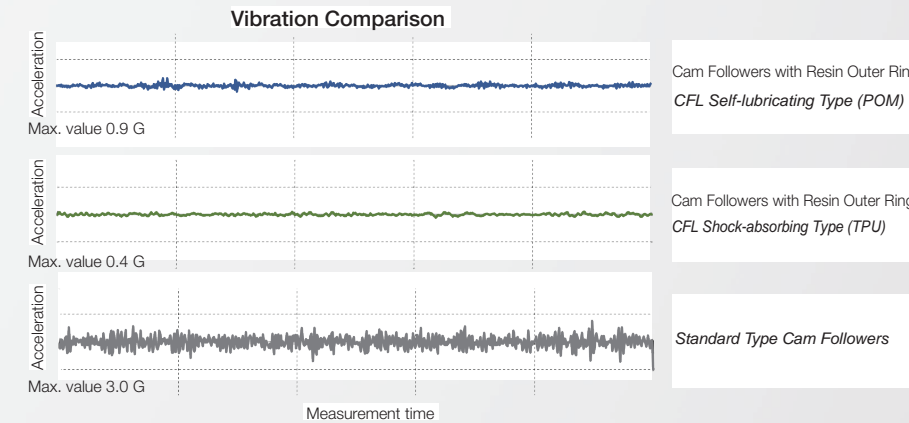

Application Examples

Available for a wide range of applications such as food processing machines, semiconductor manufacturing equipments, medical equipments, etc.

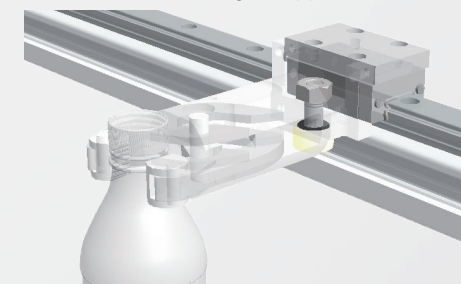

Beverages Conveyance System

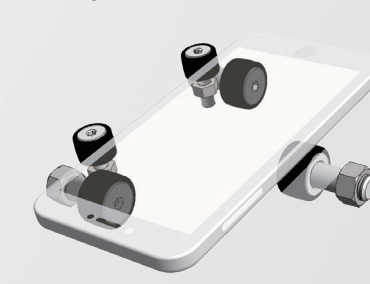

Conveying Part of Precision Machines

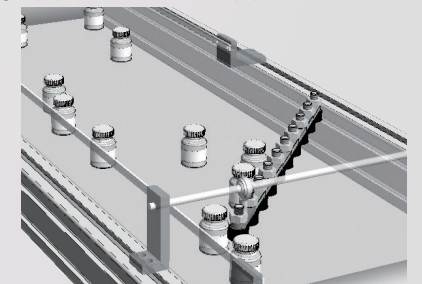

Conveying System of Pharmaceutical Products